

# 35W LED Down Light

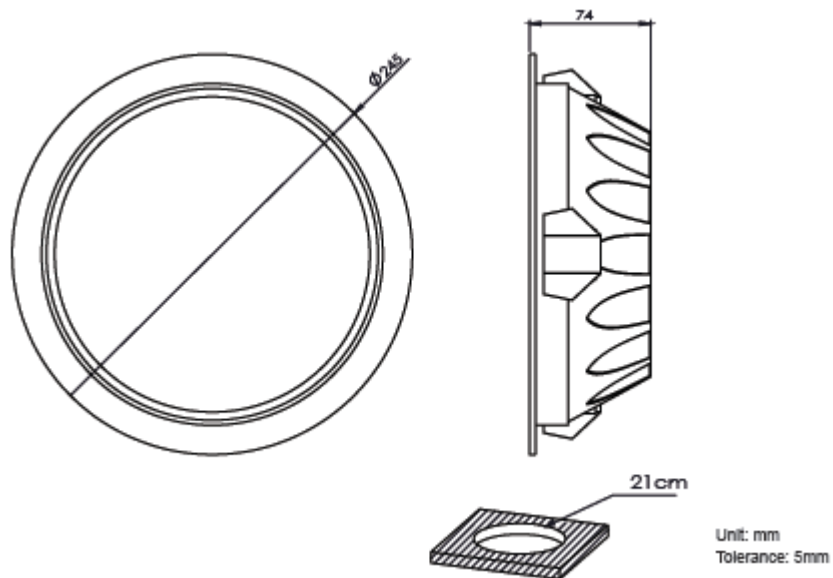

## Product Dimension



## Specifications

Item	Symbol	Typical	Unit	Remark
Input voltage	Vin	90-264	Vac	
Input frequency	Fin	50/60	Hz	
Power consumption	Pin	35	W	
Color temperature	CW	5700	K	
	NW	4000		
	WW	3000		
Luminous flux	CW	2600	lm	
	NW	2600		
	WW	2450		
Color rendering index	CRI	80		
Beam angle		95	°	
Operating Temperature	Topr	-30~40		
Warranty		2	Years	

## Scope

Item	Marketing Name	Pin	CCT
CW	CSDL35CW	35W	5700 K
NW	CSDL35NW	35W	4000 K
WW	CSDL35WW	35W	3000 K